

TOSHIBA PHOTOCOUPLER GaAs IRED & PHOTO-TRIAC

TLP3041(S),TLP3042(S),TLP3043(S)

Unit: mm

OFFICE MACHINE
HOUSEHOLD USE EQUIPMENT
TRIAC DRIVER
SOLID STATE RELAY

The TOSHIBA TLP3041 (S), TLP3042 (S), TLP3043 (S) consist of a zero voltage crossing turn-on photo-triac optically coupled to a gallium arsenide infrared emitting diode in a six lead plastic DIP package.

- Peak Off-State Voltage : 400 V (min)
- Trigger LED Current : 15 mA (max) (TLP3041(S))
10 mA (max) (TLP3042(S))
5 mA (max) (TLP3043(S))
- On-State Current : 100 mA (max)
- Isolation Voltage : 5000 Vrms (min)
- UL Recognized : UL1577, File No. E67349
- SEMKO Approved : SS EN60065
SS EN60950, File No.9841109
- BSI Approved : BS EN60065, File No.8385
BS EN60950, File No.8386
- Option (D4) type
VDE approved: DIN EN60747-5-2
Approved No. 40009302
Maximum operating insulation voltage: 890V_{PK}
Highest permissible over voltage: 8000V_{PK}
(Note):When a EN60747-5-2 approved type is needed,
please designate the "Option (D4)"

	7.62 mm pich	10.16 mm pich
	Standard Type	TLPxxxxF Type
Creepage Distance	7.0 mm (Min)	8.0 mm (Min)
Clearance	7.0 mm (Min)	8.0 mm (Min)
Insulation Thickness	0.5 mm (Min)	0.5 mm (Min)

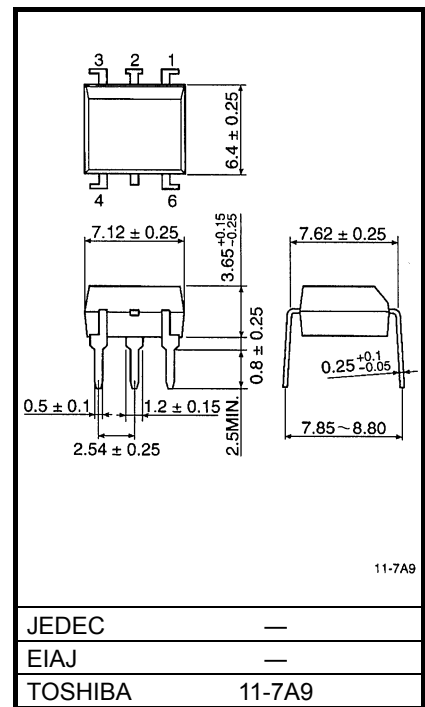

weight: 0.39g

Pin Configuration (top view)

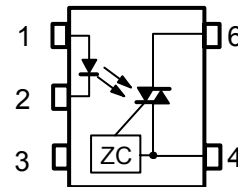

- 1: Anode
- 2: Cathode
- 3: N.C.
- 4: Terminal 1
- 6: Terminal 2

ZC:Zero-cross Circuit

Absolute Maximum Ratings (Ta = 25°C)

CHARACTERISTIC		SYMBOL	RATING	UNIT
LED	Forward Current	I_F	50	mA
	Forward Current Derating (Ta ≥ 53°C)	$\Delta I_F / ^\circ\text{C}$	-0.7	mA / °C
	Peak Forward Current (100 μs pulse, 100pps)	I_{FP}	1	A
	Power Dissipation	P_D	100	mW
	Power Dissipation Derating (Ta ≥ 25°C)	$\Delta P_D / ^\circ\text{C}$	-1.0	mW / °C
	Reverse Voltage	V_R	5	V
	Junction Temperature	T_j	125	°C
DETECTOR	Off-State Output Terminal Voltage	V_{DRM}	400	V
	On-Stage RMS Current	$I_{T(RMS)}$	100	mA
	Current		50	
	On-State Current Derating (Ta ≥ 25°C)	$\Delta I_T / ^\circ\text{C}$	-1.1	mA / °C
	Peak On-Stage Current (100 μs pulse, 120pps)	I_{TP}	2	A
	Peak Nonrepetitive Surge Current (PW = 10ms, DC = 10%)	I_{TSM}	1.2	A
	Power Dissipation	P_D	300	mW
	Power Dissipation Derating (Ta ≥ 25°C)	$\Delta P_D / ^\circ\text{C}$	-4.0	mW / °C
	Junction Temperature	T_j	115	°C
	Storage Temperature Range	T_{stg}	-55 ~ 150	°C
Operating Temperature Range	T_{opr}	-40 ~ 100	°C	
Lead Soldering Temperature (10s)	T_{sol}	260	°C	
Total Package Power Dissipation	P_T	330	mW	
Total Package Power Dissipation Derating (Ta ≥ 25°C)	$\Delta P_T / ^\circ\text{C}$	-4.4	mW / °C	
Isolation Voltage (AC, 1 min., R.H. ≤ 60%)	BV_S	5000	Vrms	

Note: Using continuously under heavy loads (e.g. the application of high temperature/current/voltage and the significant change in temperature, etc.) may cause this product to decrease in the reliability significantly even if the operating conditions (i.e. operating temperature/current/voltage, etc.) are within the absolute maximum ratings.

Please design the appropriate reliability upon reviewing the Toshiba Semiconductor Reliability Handbook ("Handling Precautions"/"Derating Concept and Methods") and individual reliability data (i.e. reliability test report and estimated failure rate, etc).

Note 1: Device considered a two terminal device: Pins 1, 2 and 3 shorted together and pins 4 and 6 shorted together.

Recommended Operating Conditions

CHARACTERISTIC	SYMBOL	MIN	TYP.	MAX	UNIT
Supply Voltage	V_{AC}	—	—	120	Vac
Forward Current	I_F^*	15	20	25	mA
Peak On-Stage Current	I_{TP}	—	—	1	A
Operating Temperature	T_{opr}	-25	—	85	°C

Note: Recommended operating conditions are given as a design guideline to obtain expected performance of the device. Additionally, each item is an independent guideline respectively. In developing designs using this product, please confirm specified characteristics shown in this document.

* : In the case of TLP3042

Individual Electrical Characteristics (Ta = 25°C)

CHARACTERISTIC		SYMBOL	TEST CONDITION	MIN	TYP.	MAX	UNIT
LED	Forward Voltage	V_F	$I_F = 10\text{mA}$	1.0	1.15	1.3	V
	Reverse Current	I_R	$V_R = 5\text{V}$	—	—	10	μA
	Capacitance	C_T	$V = 0, f = 1\text{MHz}$	—	10	—	pF
DETECTOR	Peak Off-State Current	I_{DRM}	$V_{DRM} = 400\text{V}$	—	10	100	nA
	Peak On-Stage Voltage	V_{TM}	$I_{TM} = 100\text{mA}$	—	1.7	3.0	V
	Holding Current	I_H	—	—	0.6	—	mA
	Critical Rate of Rise of Off-State Voltage	dv / dt	$V_{in} = 120\text{Vrms}, T_a = 85^\circ\text{C}$ (Fig.1)	200	500	—	$\text{V} / \mu\text{s}$
	Critical Rate of Rise of Commutating Voltage	$dv / dt(c)$	$V_{in} = 30\text{Vrms}, I_T = 15\text{mA}$ (Fig.1)	—	0.2	—	$\text{V} / \mu\text{s}$

Coupled Electrical Characteristics (Ta = 25°C)

CHARACTERISTIC		SYMBOL	TEST CONDITION	MIN	TYP.	MAX	UNIT
Trigger LED Current	TLP3041(S)	I_{FT}	$V_T = 3\text{V}$	—	—	15	mA
	TLP3042(S)			—	5	10	
	TLP3043(S)			—	—	5	
Inhibit Voltage	V_{IH}	$I_F = \text{Rated } I_{FT}$	—	—	40	V	
Leakage in Inhibited State	I_{IH}	$I_F = \text{Rated } I_{FT}$ $V_T = \text{Rated } V_{DRM}$	—	100	300	μA	
Capacitance Input to Output	C_S	$V_S = 0, f = 1\text{MHz}$	—	0.8	—	pF	
Isolation Resistance	R_S	$V_S = 500\text{V}$ (R.H. $\leq 60\%$)	5×10^{10}	10^{14}	—	Ω	
Isolation Voltage	BV_S	AC, 1 minute	5000	—	—	Vrms	
		AC, 1 second (in oil)	—	10000	—		
		DC, 1 minute (in oil)	—	10000	—	Vdc	

Fig. 1 dv / dt test circuit

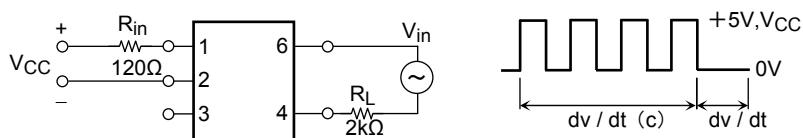

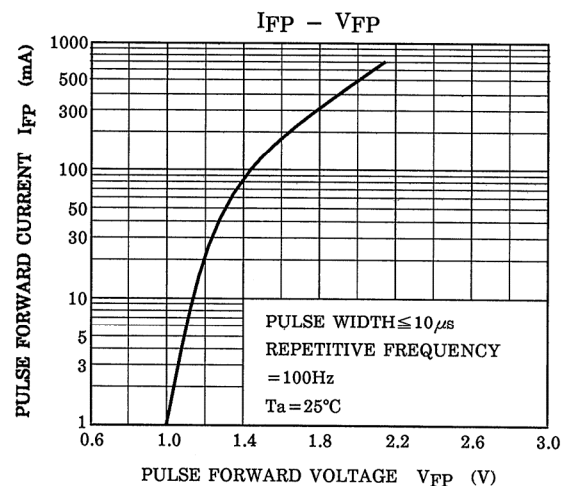
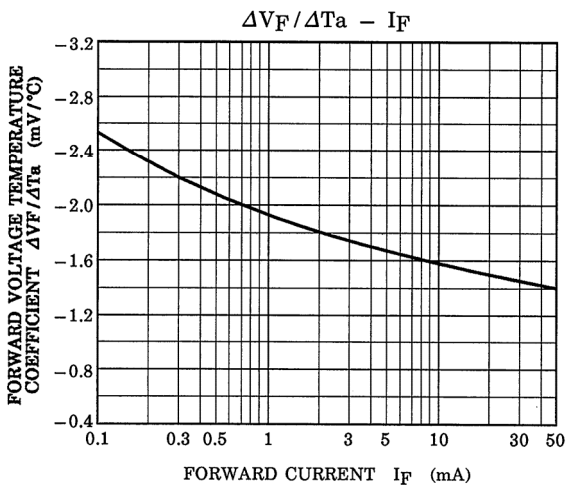
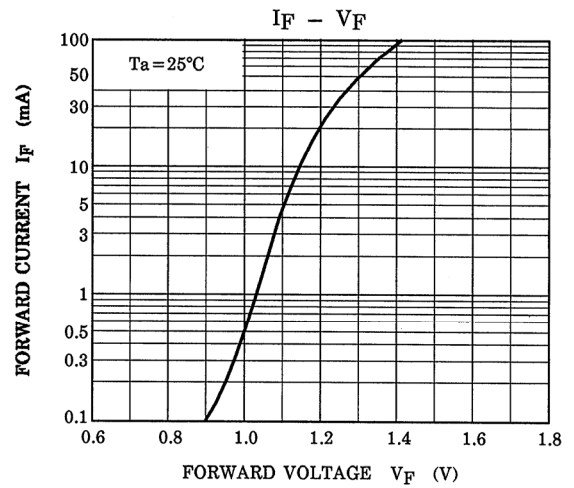
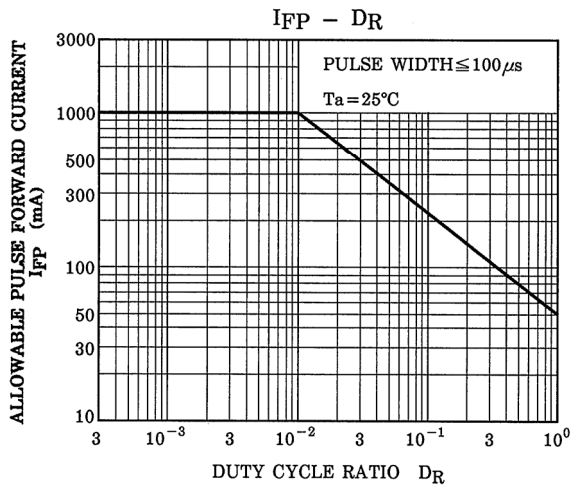
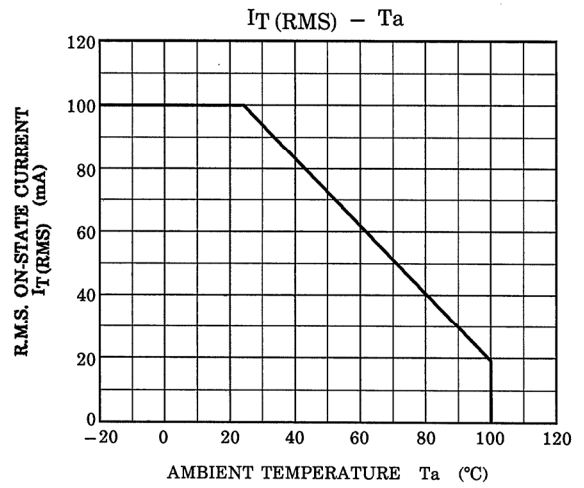
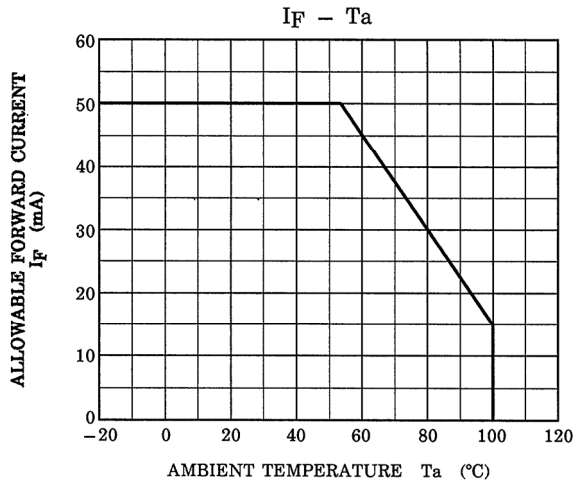

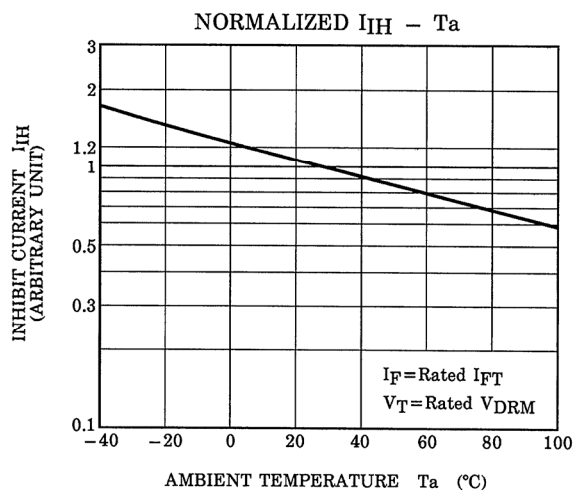
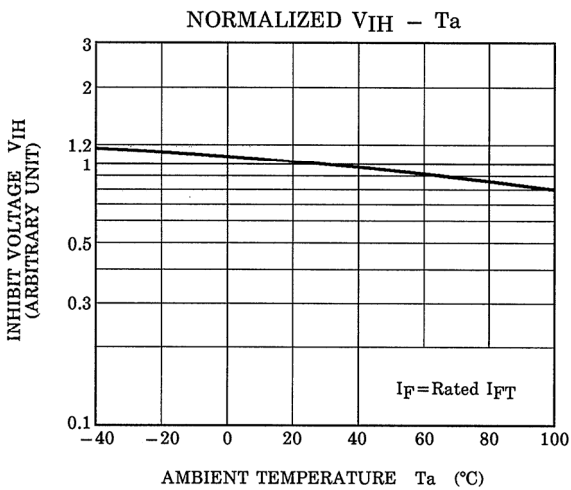
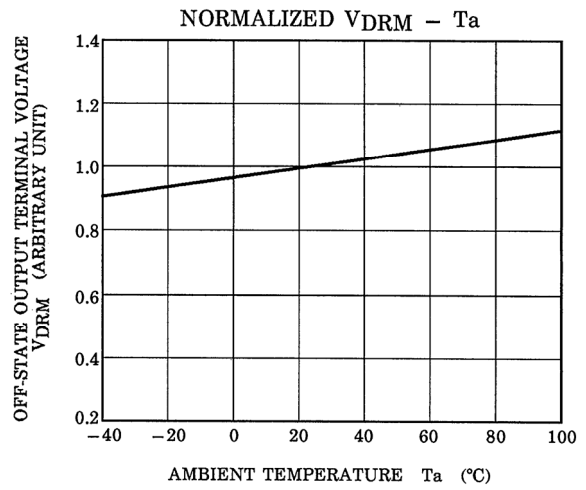
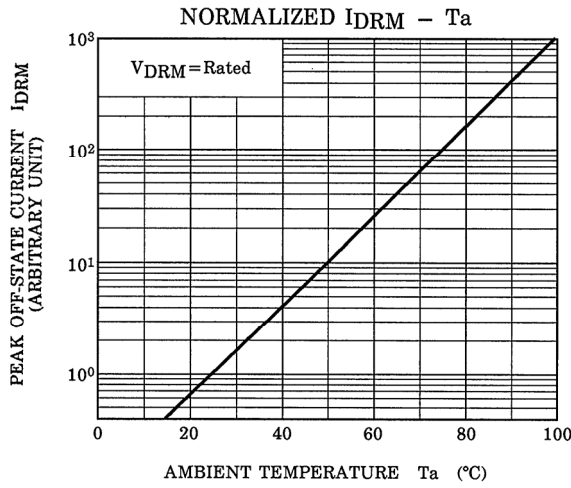
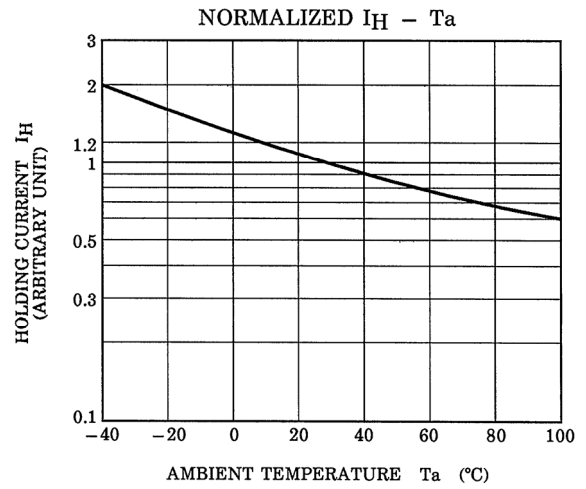
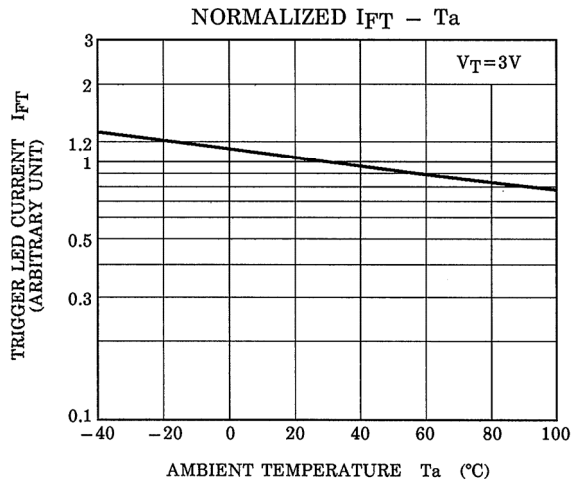

RESTRICTIONS ON PRODUCT USE

20070701-EN

- The information contained herein is subject to change without notice.
- TOSHIBA is continually working to improve the quality and reliability of its products. Nevertheless, semiconductor devices in general can malfunction or fail due to their inherent electrical sensitivity and vulnerability to physical stress. It is the responsibility of the buyer, when utilizing TOSHIBA products, to comply with the standards of safety in making a safe design for the entire system, and to avoid situations in which a malfunction or failure of such TOSHIBA products could cause loss of human life, bodily injury or damage to property.
In developing your designs, please ensure that TOSHIBA products are used within specified operating ranges as set forth in the most recent TOSHIBA products specifications. Also, please keep in mind the precautions and conditions set forth in the "Handling Guide for Semiconductor Devices," or "TOSHIBA Semiconductor Reliability Handbook" etc.
- The TOSHIBA products listed in this document are intended for usage in general electronics applications (computer, personal equipment, office equipment, measuring equipment, industrial robotics, domestic appliances, etc.). These TOSHIBA products are neither intended nor warranted for usage in equipment that requires extraordinarily high quality and/or reliability or a malfunction or failure of which may cause loss of human life or bodily injury ("Unintended Usage"). Unintended Usage include atomic energy control instruments, airplane or spaceship instruments, transportation instruments, traffic signal instruments, combustion control instruments, medical instruments, all types of safety devices, etc.. Unintended Usage of TOSHIBA products listed in this document shall be made at the customer's own risk.
- The products described in this document shall not be used or embedded to any downstream products of which manufacture, use and/or sale are prohibited under any applicable laws and regulations.
- The information contained herein is presented only as a guide for the applications of our products. No responsibility is assumed by TOSHIBA for any infringements of patents or other rights of the third parties which may result from its use. No license is granted by implication or otherwise under any patents or other rights of TOSHIBA or the third parties.
- GaAs(Gallium Arsenide) is used in this product. The dust or vapor is harmful to the human body. Do not break, cut, crush or dissolve chemically.
- Please contact your sales representative for product-by-product details in this document regarding RoHS compatibility. Please use these products in this document in compliance with all applicable laws and regulations that regulate the inclusion or use of controlled substances. Toshiba assumes no liability for damage or losses occurring as a result of noncompliance with applicable laws and regulations.